

118. L.L. Maschinenfabrik

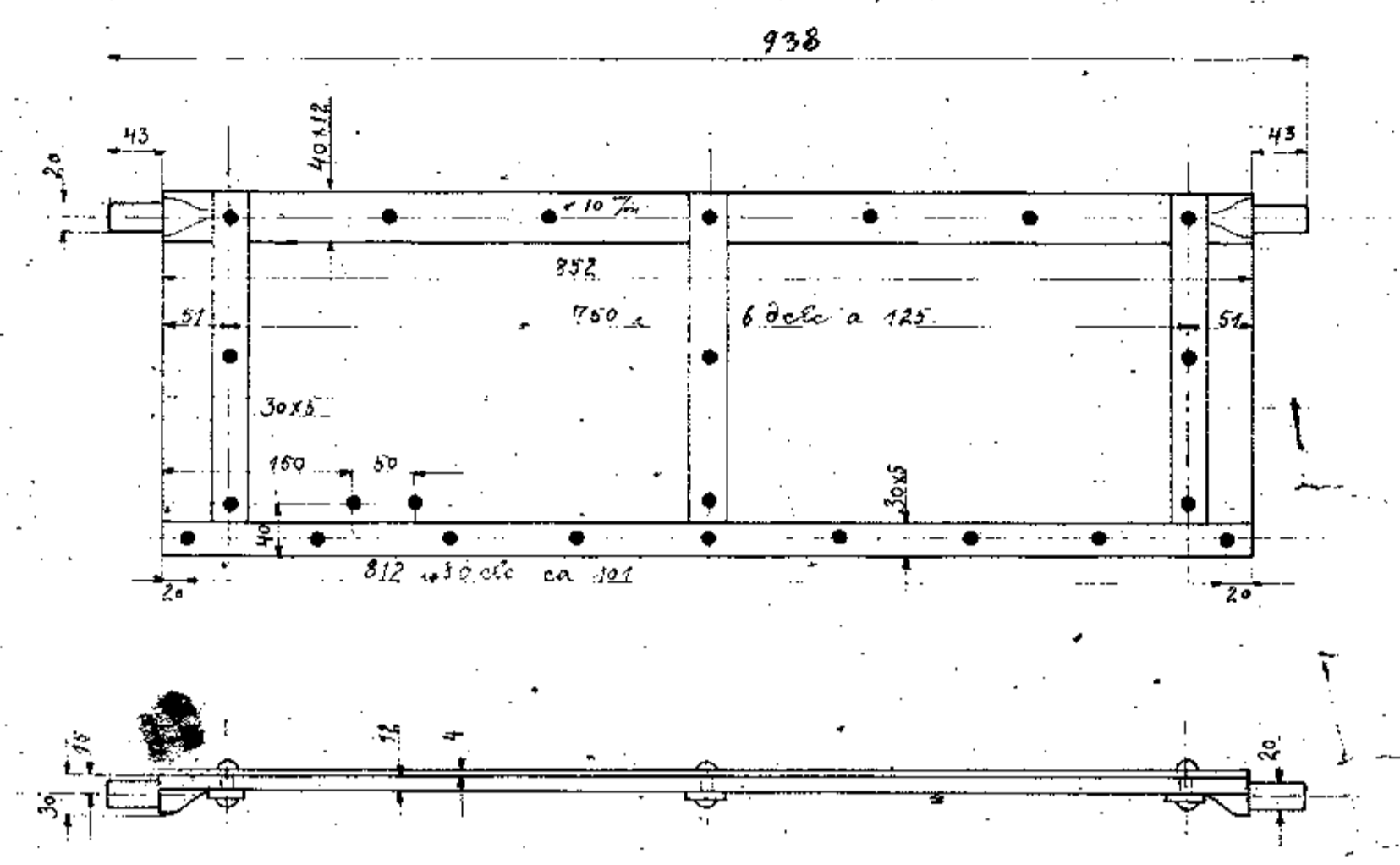

Maschine (Paranis) gelagert am festen Lager

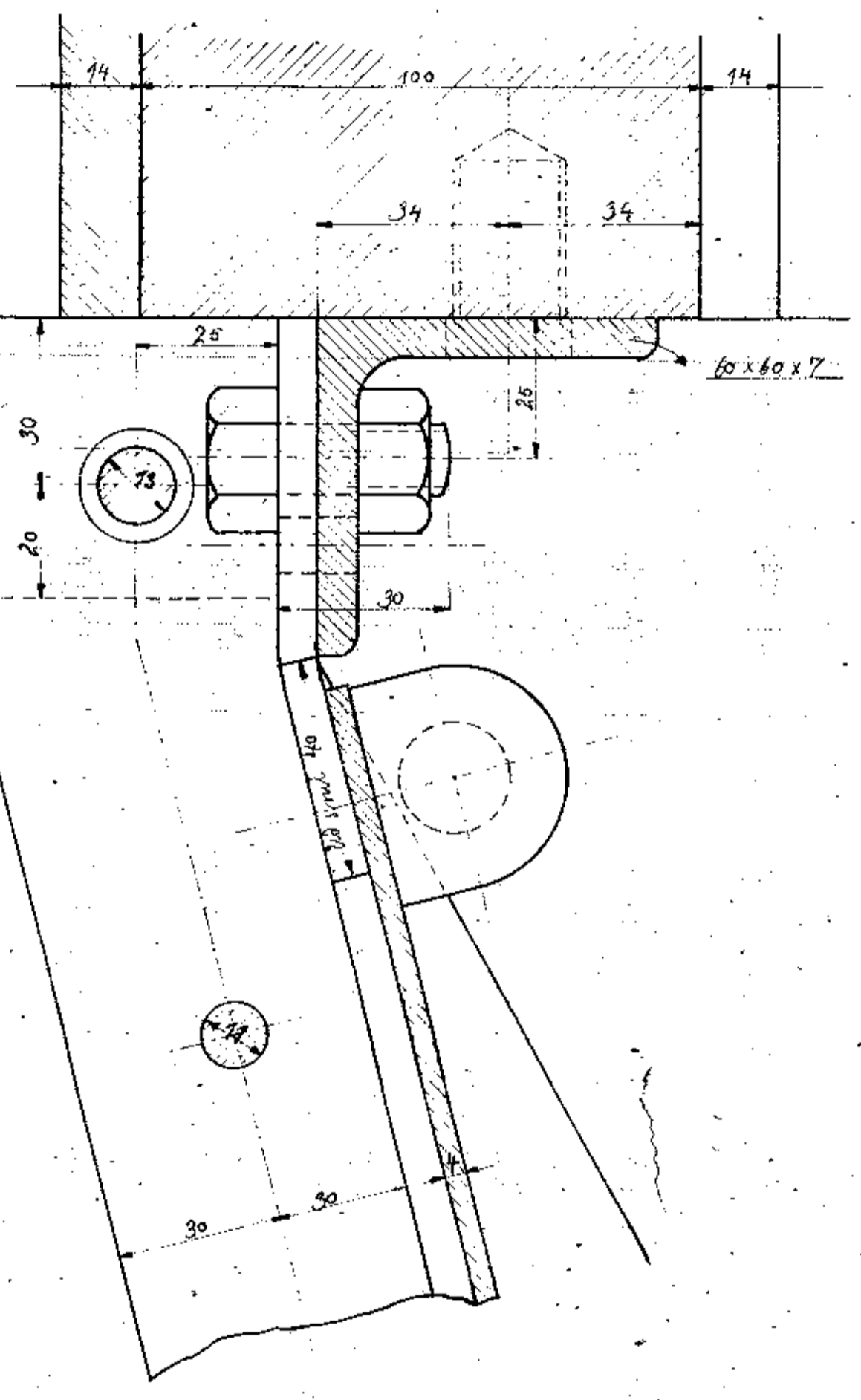
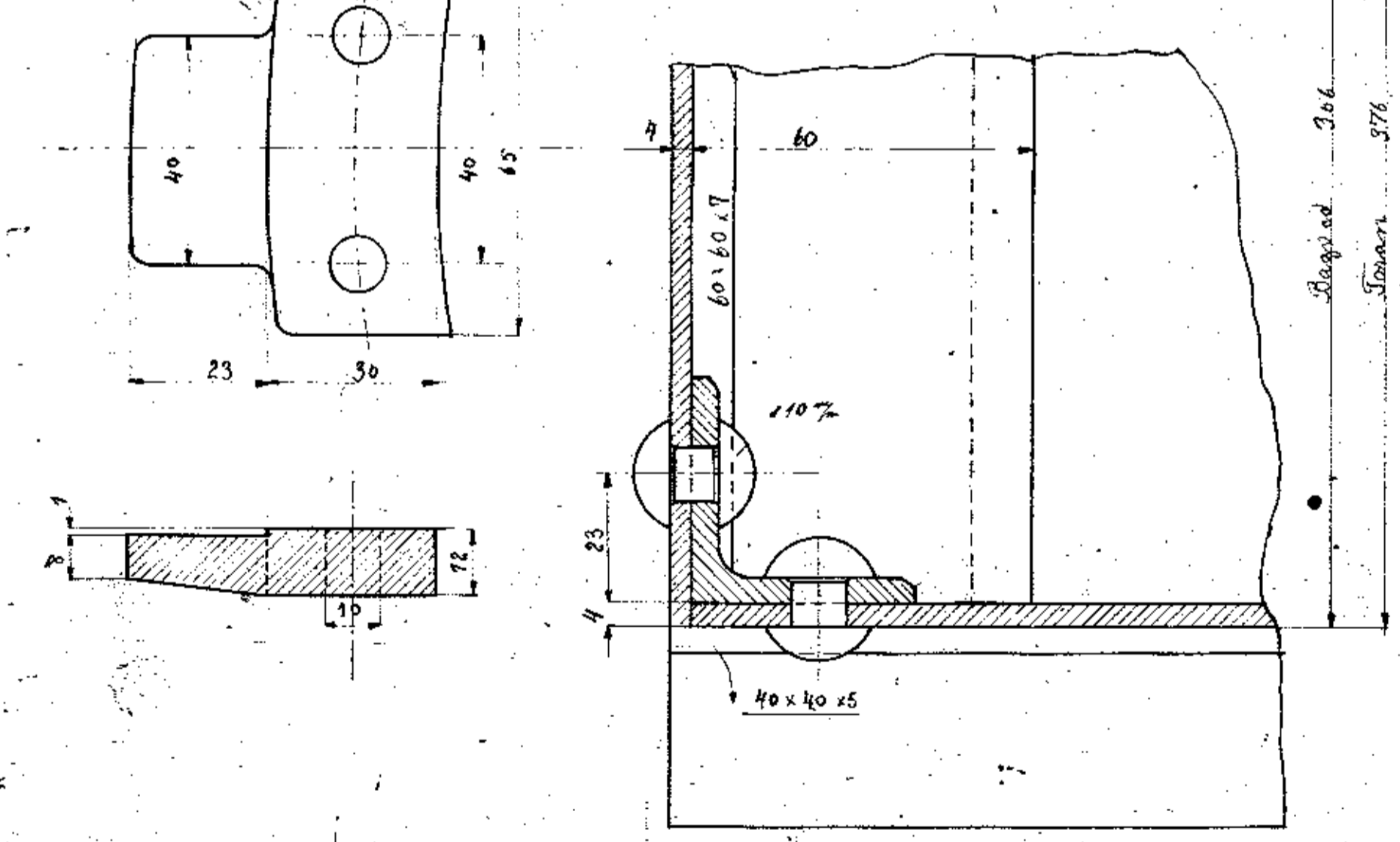
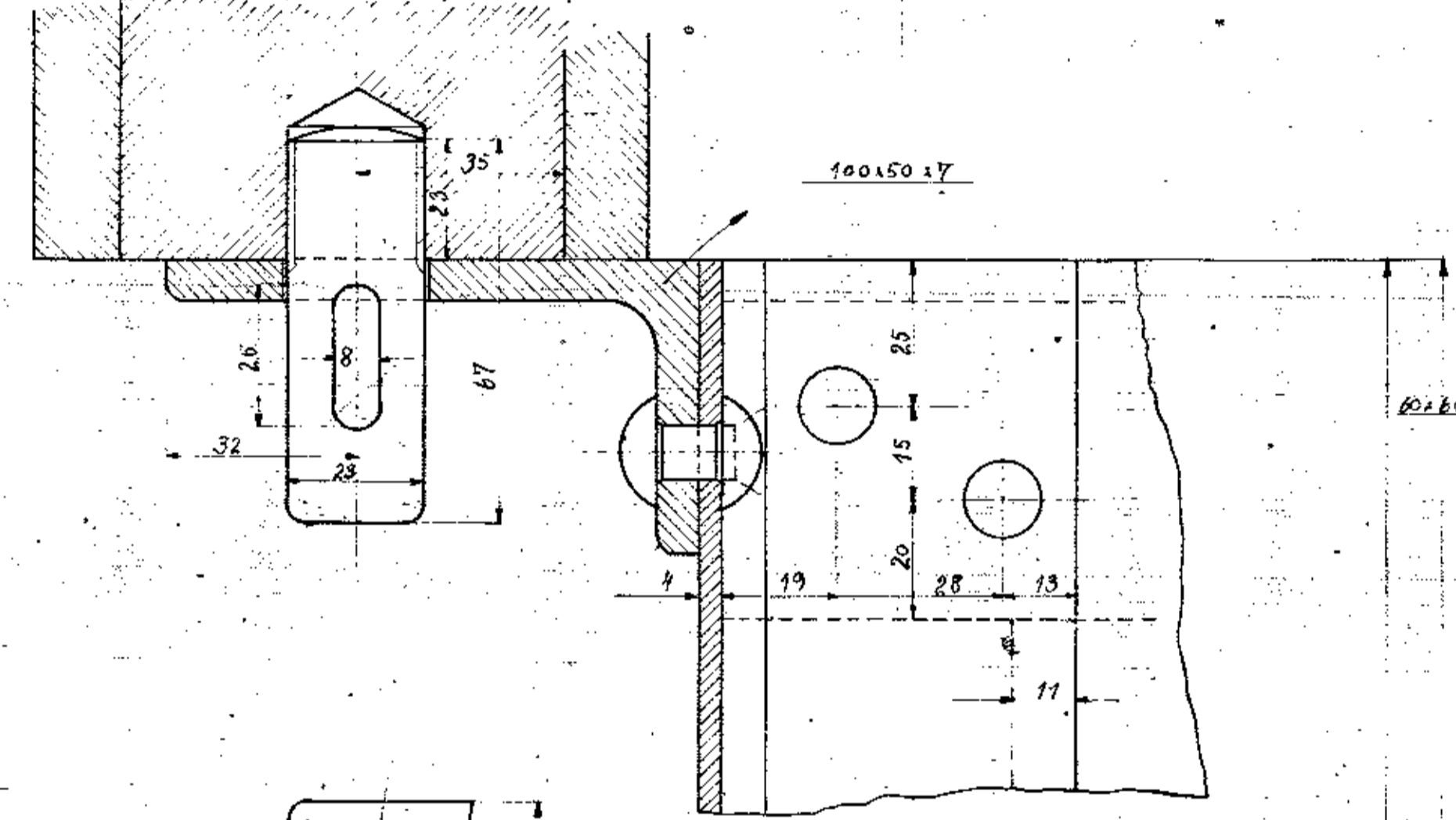
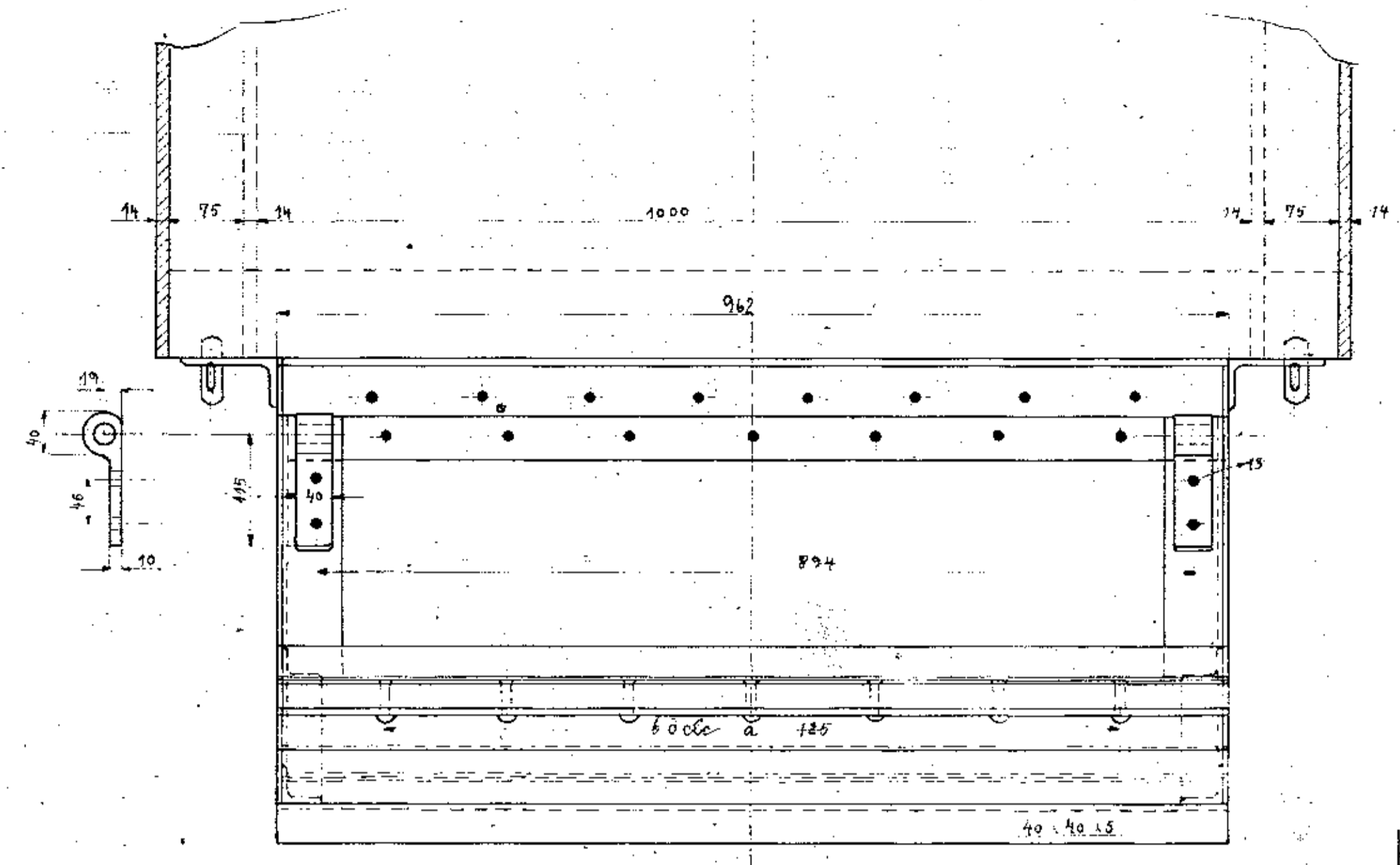
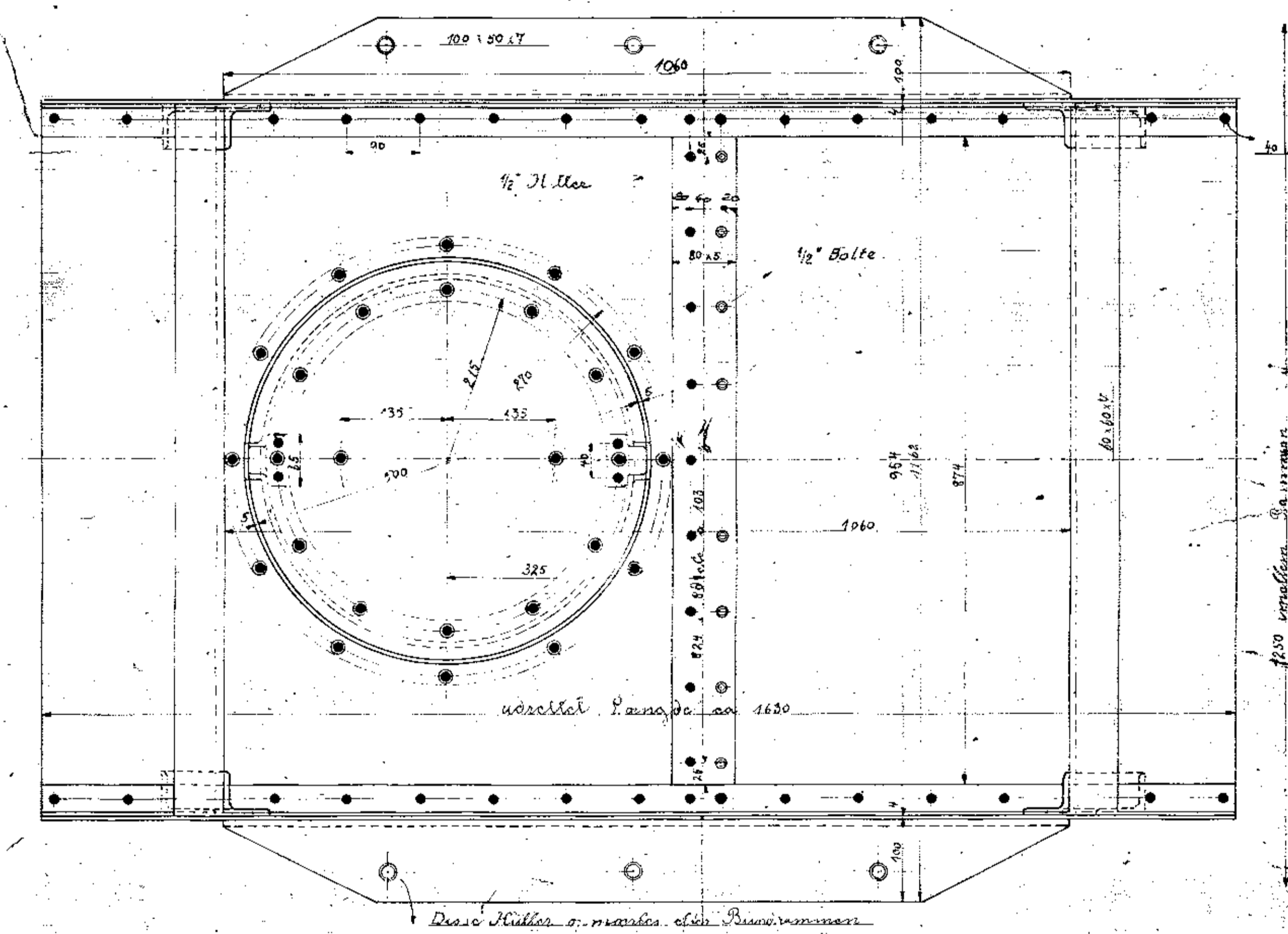
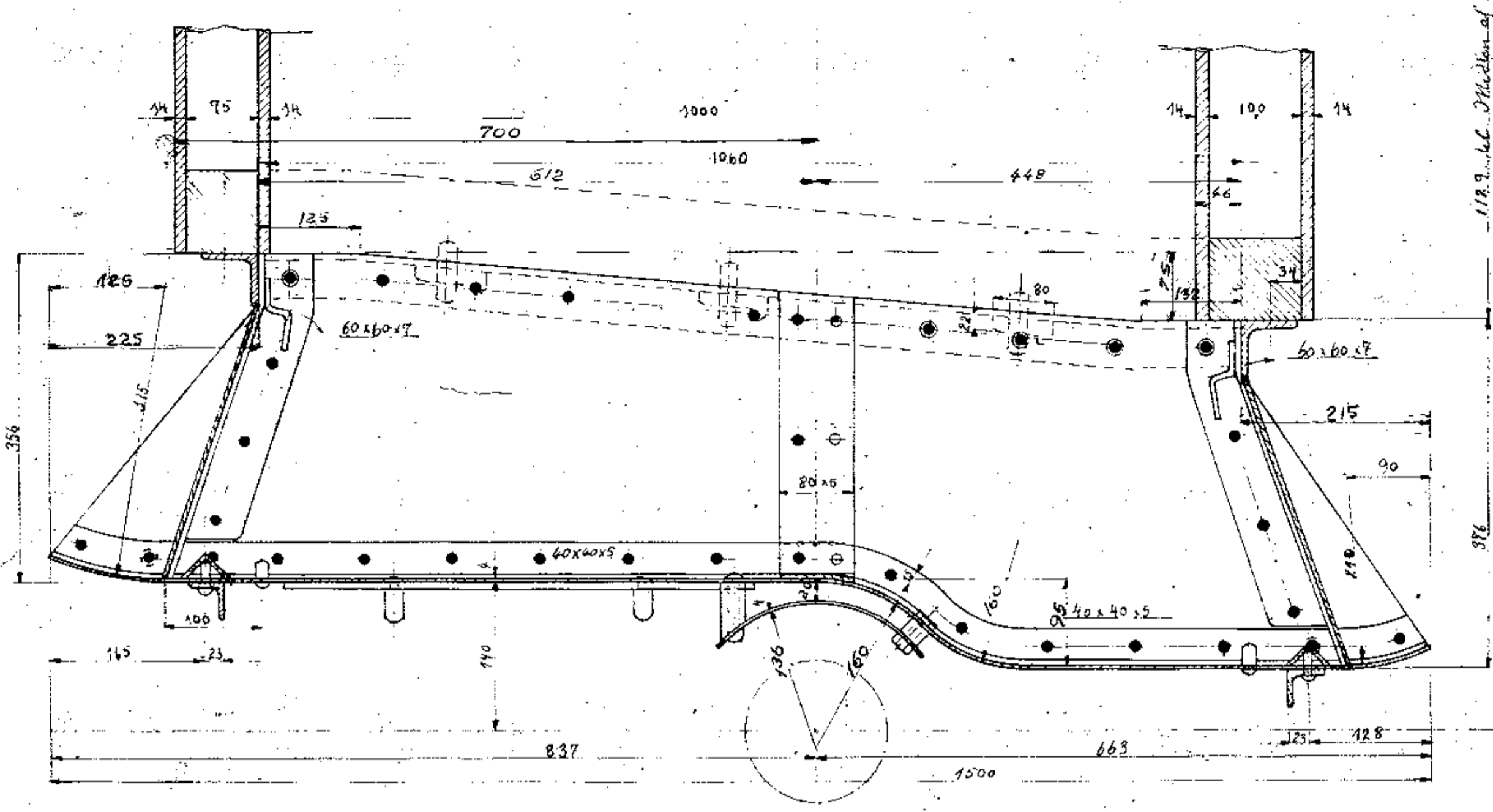
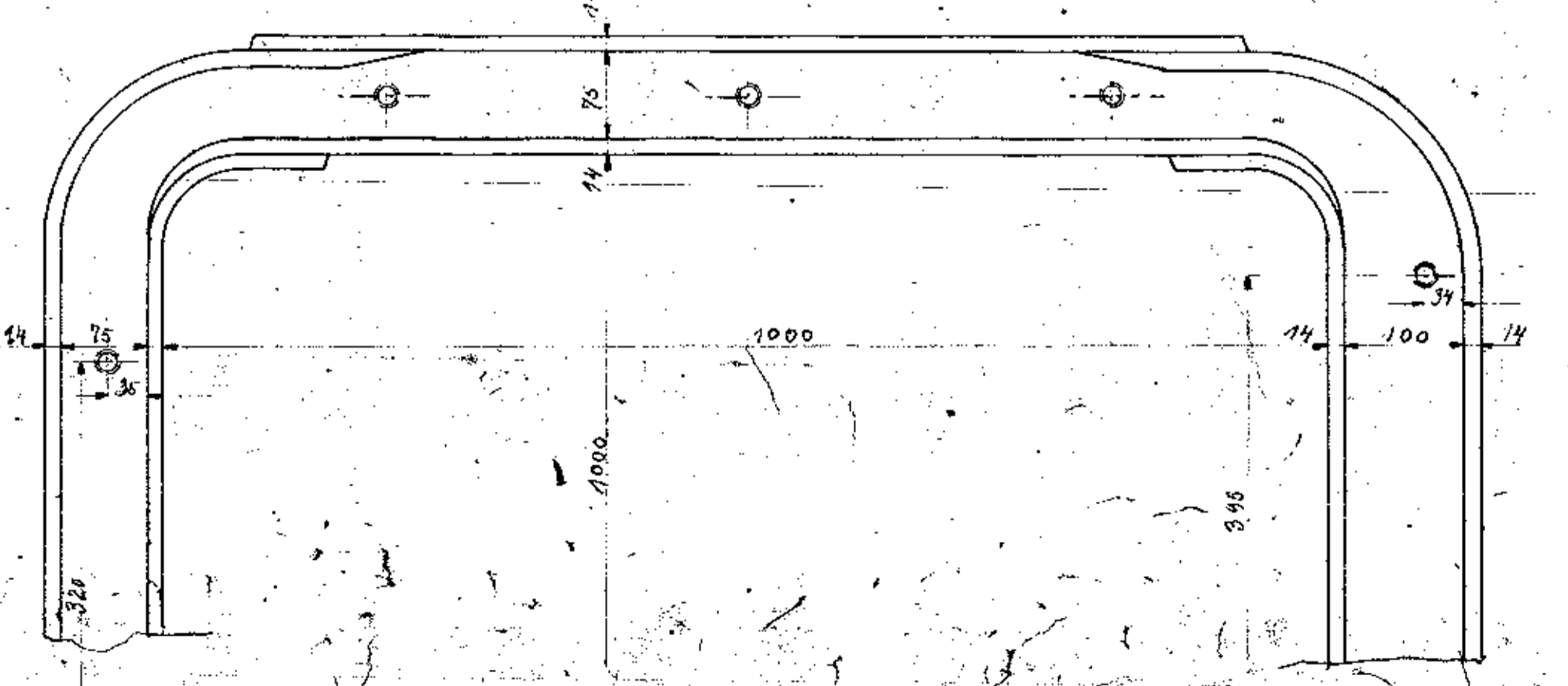
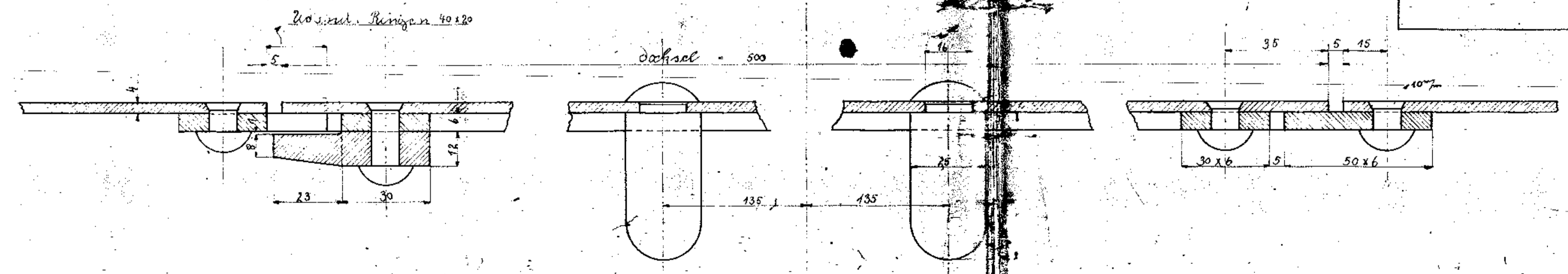
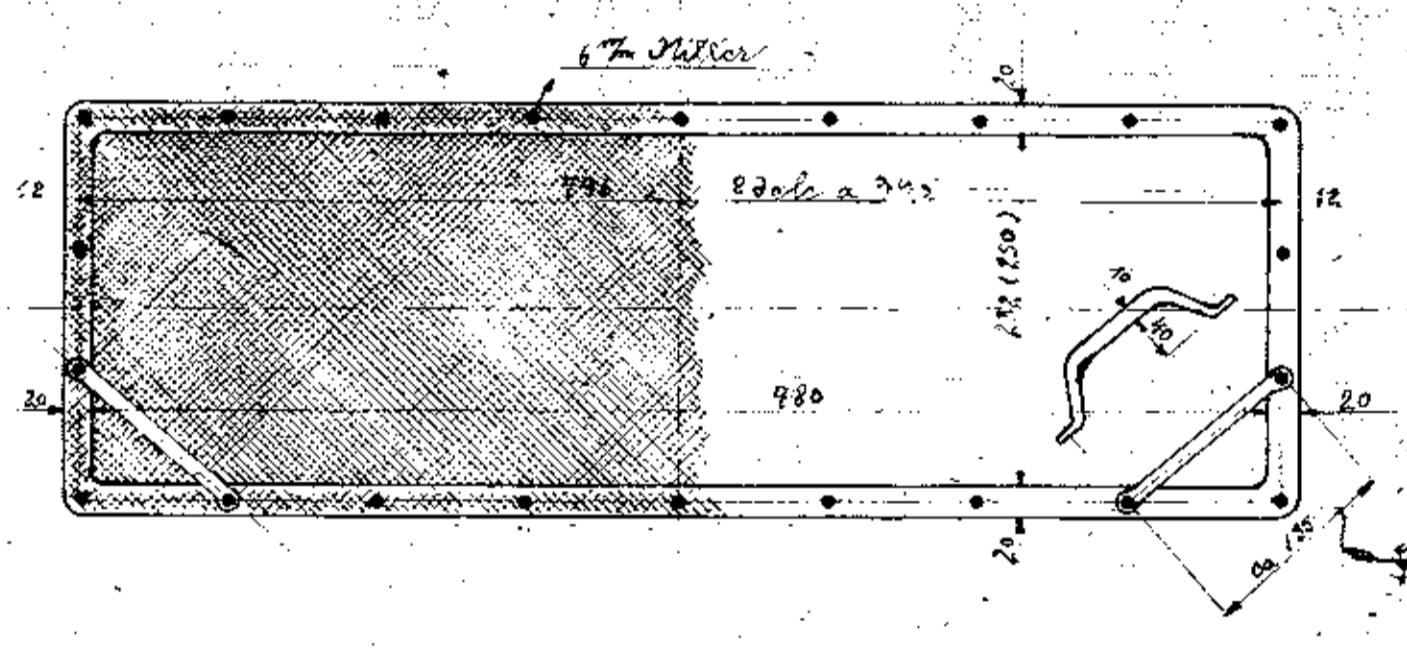

Aschkasse für

O.M.B. Loh 1-6.
O.K.M.J. Loh 4.